

SATK series wall-mounted indirect Heat Interface Unit

SATK32 series

INSTRUCTIONS FOR INSTALLATION, COMMISSIONING AND MAINTENANCE

All languages are available on:

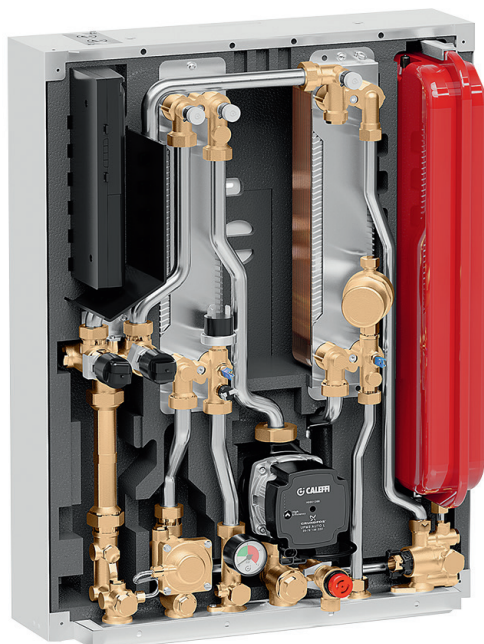

Product range

SATK32103	Indirect wall-mounted HIU for instantaneous domestic hot water production, capacity 50 kW ⁽¹⁾ .
SATK32105	Indirect wall-mounted HIU for instantaneous domestic hot water production, capacity 60 kW ⁽¹⁾ .
SATK32107	Indirect wall-mounted HIU for instantaneous domestic hot water production, for low temperature heating networks.

⁽¹⁾ Primary side head > 50 kPa, primary flow temperature 70 °C, DHW 10 - 50 °C

Function

The SATK series HIU allows independent control of heat regulation and domestic hot water production within centralised heating systems or systems served by district heating networks. The heat interface unit features exceptional flexibility of installation and remote controllable smart electronic functions designed to enhance efficiency of the system.

CONTENTS

Safety instructions	2
Dimensions - Technical specifications	3
Hydraulic components and diagram	4
Hydraulic installation	5
Electrical installation	8
Commissioning	9
Remote user interface quick guide	10
Heating function	12
DHW function - Comfort functions	13
Anti-legionella function	14
Primary flow rate limitation	14
Circulator - curves and setting	15
Auxiliary microswitch	16
Modbus	17
Safety and alarms	18
Electronic circuit board	19
Periodic maintenance	20
Troubleshooting	22
Commissioning check-list	24

SAFETY INSTRUCTIONS



WARNINGS

These instructions must be read and understood before installing and servicing the device.
IMPORTANT! FAILURE TO FOLLOW THESE INSTRUCTIONS COULD RESULT IN A SAFETY HAZARD!

- 1 The device must be installed, commissioned and serviced by qualified technical personnel in accordance with national regulations and/or relevant local requirements.
- 2 If the device is not installed, commissioned and serviced correctly in accordance with the instructions provided in this manual, it may not work properly and may endanger the user.
- 3 Clean the pipes of any particles, rust, incrustations, limescale, welding slag and any other contaminants. The hydraulic circuit must be clean.
- 4 Make sure that all connection fittings are watertight.
- 5 When connecting water pipes, take care not to subject the threads to excessive mechanical stress. Over time this could result in breakage, with water leaks causing damage and/or injury.
- 6 Water temperatures higher than 50 °C may cause severe burns. When installing, commissioning and servicing the device, take the necessary precautions so that these temperatures will not be hazardous for people.
- 7 In the case of particularly hard or impure water, the device must be fitted for filtering and treating the water before it enters the device, in accordance with current legislation. Otherwise the device may be damaged and will not work properly.
Important note: system washing must take place in accordance with current local regulations. In any case, we recommend the use of specific by-passes for the first washing cycles, in order to avoid water containing impurities from flowing into the device. At the end of the procedure, make sure all the system and device filters are clean.
- 8 Any use of the device other than its intended use is prohibited.
- 9 Any combination of the device with other system components must be made while taking the operational characteristics of both units into consideration.
- 10 An combination coupling could compromise the operation of the device and/or system.

IMPORTANT: Risk of electric shock. Live parts. Shut off the electric supply before opening the device enclosure.

- 1 During installation and maintenance operations, always avoid direct contact with live or potentially hazardous parts.
- 2 The device must not be exposed to dripping water or humidity, direct sunlight, the weather, heat sources or high intensity electromagnetic fields. This device cannot be used in areas at risk of explosion or fire.
- 3 The device must be connected to an independent two-pole switch. If work must be carried out on the device, cut off the electric supply first. Do not use devices with automatic or time reset, or which may be reset accidentally.
- 4 Use suitable automatic protection devices in accordance with the electrical characteristics of the region in which the device is installed and in compliance with current legislation.
- 5 The device must always be earthed before it is connected to the electric supply. If the device must be removed, always disconnect the earth connection after disconnecting the electric supply conductors. Check that the earth connection has been made to the highest of standards under applicable legislation.
- 6 Electrical installation must only be carried out by a qualified technician, in accordance with legal requirements.
- 7 The appliance does not contain asbestos or mercury.
- 8 The device is not designed for use by persons of reduced mental, physical or sensory capacity (including children) or persons lacking experience, unless they are supervised or instructed in use of the device by a person responsible for their personal safety.

NOTES:

- 1 Install water hammer arresters to compensate for any overpressure in the domestic water circuit;
- 2 In the presence of hot water recirculation or if a check valve is fitted into the domestic cold water inlet, suitable devices must be used to accommodate the expansion of the medium contained within the system and the heat interface unit;
- 3 All hydraulic connections must be visually checked while pressurising the system. Vibration during transport may cause the connections to become loose. If a fitting needs to be tightened apply a proper tightening torque, otherwise the components may be damaged by overtightening.

For the updated version of the technical documentation refer to www.caleffi.it.

Key to symbols



Primary circuit flow



Primary circuit return



High temperature circuit flow



High temperature circuit return



Low temperature circuit flow



Low temperature circuit return



Domestic hot water outlet



Domestic cold water inlet



Medium temperature circuit flow



Medium temperature circuit return

LEAVE THIS MANUAL AS A REFERENCE GUIDE FOR THE USER. DISPOSE OF THE PRODUCT IN COMPLIANCE WITH CURRENT LEGISLATION
THE MANUFACTURER RESERVES THE RIGHT TO CEASE PRODUCTION AT ANY TIME AND TO MAKE ANY CHANGES DEEMED USEFUL OR NECESSARY
WITHOUT THE OBLIGATION OF PRIOR NOTICE.

Dimensions

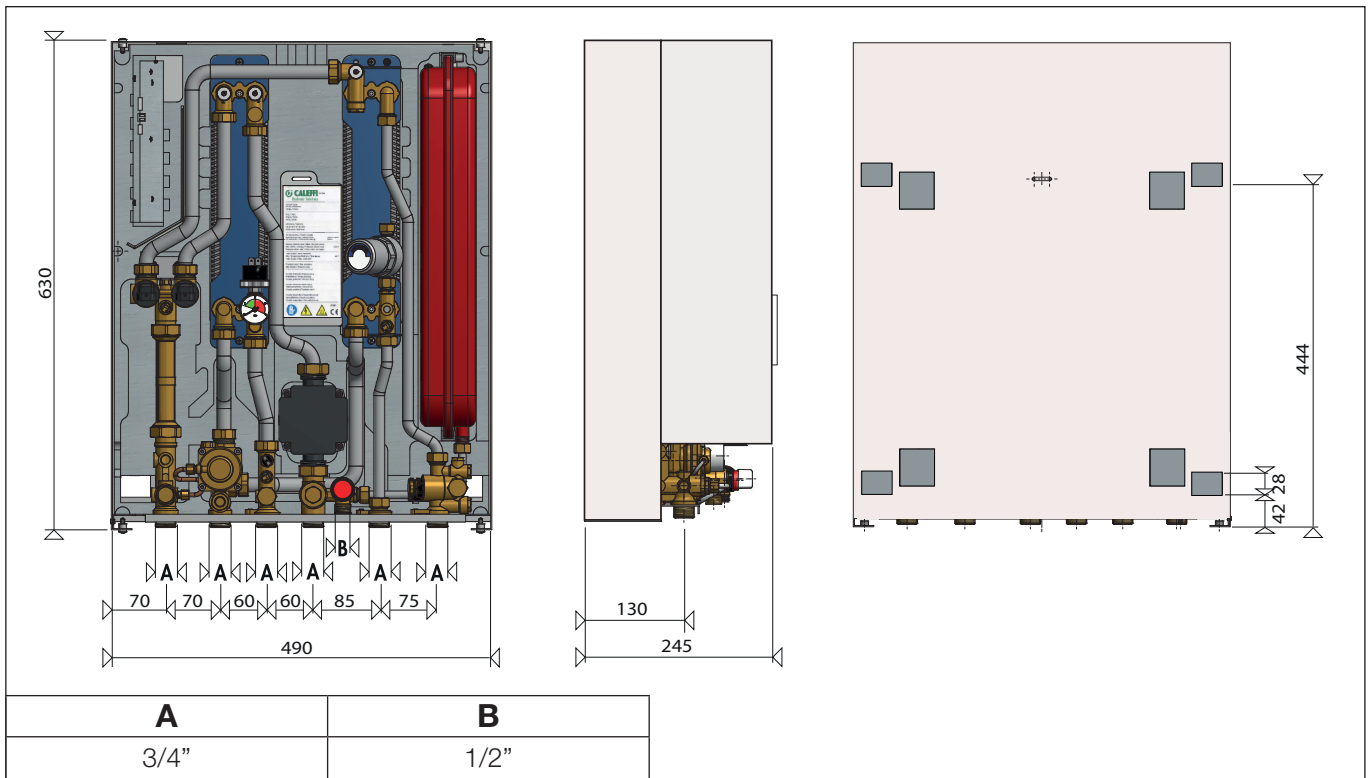

Description of connections

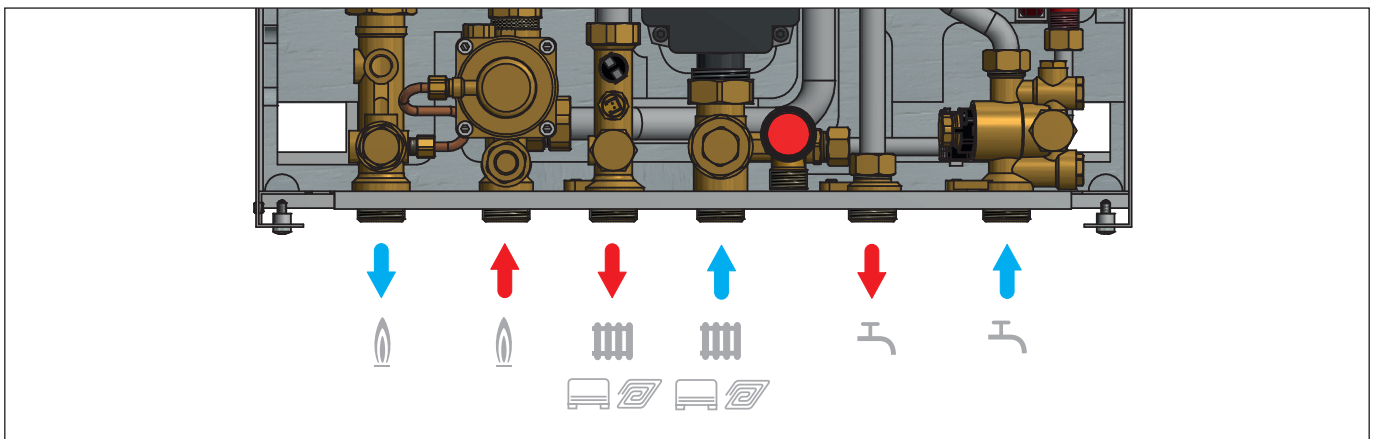

SATK32 technical specifications

Medium:	water
Max. percentage of glycol:	30 %
Maximum medium temperature:	90 °C
Max. working pressure:	- primary circuit: 1,6 MPa (16 bar) - secondary circuit: 0,3 MPa (3 bar) - domestic circuit: 1 MPa (10 bar)
Primary circuit nominal flow rate:	1,2 m³/h
Nominal pressure loss on primary circuit:	Δp 50 kPa (0,5 bar)
Maximum pressure on primary circuit:	Δp 600 kPa (6 bar)
Domestic water circuit max. flow rate:	24 l/min (0,4 l/s)
Minimum flow rate to activate domestic water flow meter:	2 l/min ±0,3
Electric supply:	230 V ~ (AC) ±10 % 50Hz
Max power consumption:	80 W
Protection class:	IP 40
Pump:	UPM3 15-70
Actuators:	24 V stepper motor
Probes:	NTC 10 kΩ
Safety relief valve setting:	0,3 MPa (3 bar)
Safety thermostat:	55 °C ±3
Expansion vessel:	- capacity: 7 l - pre-charge value: 0,1 MPa (1 bar)
Pressure switch:	- opening: 40 kPa (0,4 bar) - closing: 0 kPa (0,8 bar)

Materials

Components:	brass UNI EN12165 CW617N
Connecting pipes:	steel
Frame:	RAL 9010 painted steel
Exchanger:	stainless steel brazed with copper

Insulation

Material:	EPP
Density:	45 kg/m³
Working temperature range:	3-90 °C
Thermal conductivity:	0,04 W/mK

Characteristic components

1. Frame
2. Controller
3. Heating exchanger primary circuit air venting/drain
4. Heating exchanger secondary circuit air venting/drain
5. Heating exchanger
6. Pressure switch
7. 2-way modulating valve - Heating
8. 2-way modulating valve - DHW
9. Return temperature probe
10. Pressure gauge
11. Safety thermostat
12. 130 mm heat meter template
13. 1/4" F pressure test port
14. Connection for M10x1 heat meter return probe
15. Primary drain cock
16. Connection for M10x1 heat meter flow probe
17. Mesh strainer + 1/4" F pressure test port
18. Differential pressure regulating valve
19. Secondary drain cock + mesh strainer
20. Safety relief valve
21. Flow meter (turbine + sensor)
22. Mesh strainer
23. Heating flow temperature probe
24. Pump
25. DHW temperature probe
26. Expansion vessel
27. Water hammer arrester
28. DHW exchanger
29. DHW exchanger primary circuit air venting/drain

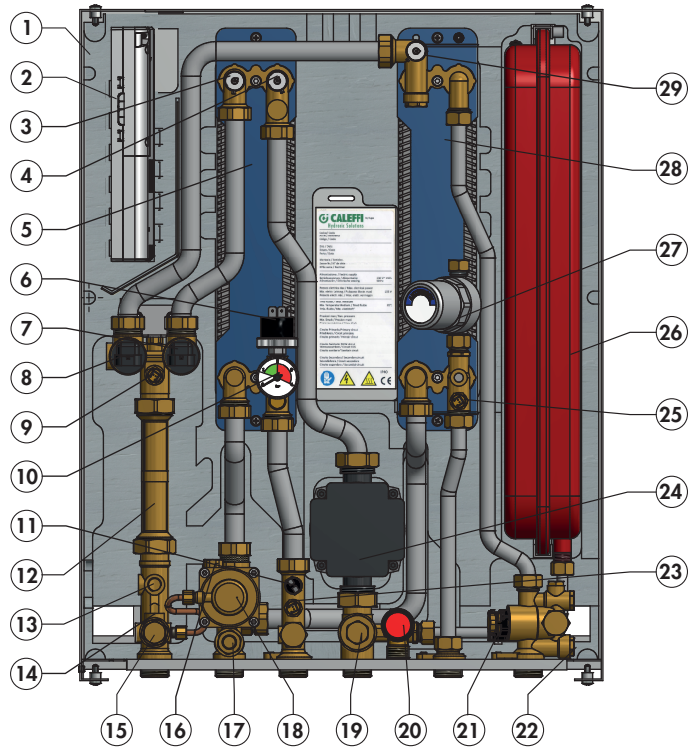

Hydraulic diagram

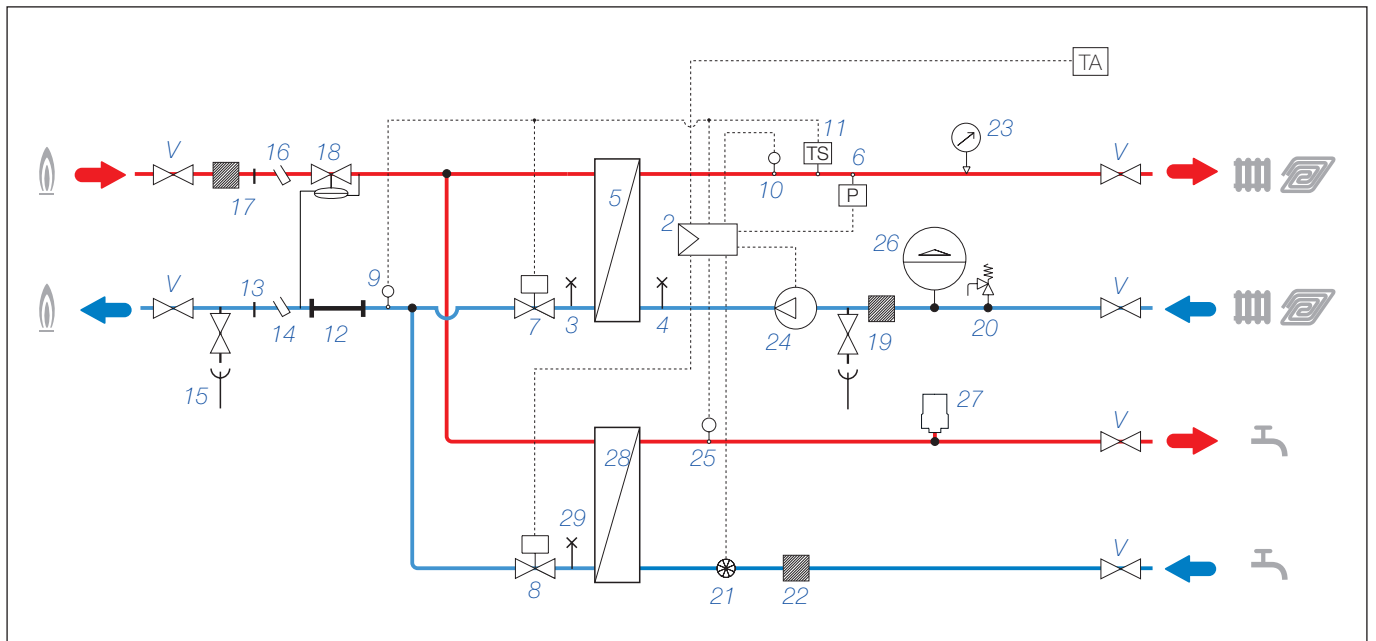

Hydraulic installation

Notes for the installer

The SATK series HIU is designed for installation in a sheltered domestic environment (or similar), therefore it cannot be installed or used outdoors, i.e. in areas directly exposed to the weather. Outdoor installation may cause malfunctioning and hazards.

If the appliance is enclosed inside or between cabinets, sufficient space must be provided for routine maintenance procedures. It is recommended NOT to place electrical devices underneath the HIU, as they may be damaged in the event of safety relief valve activation if not connected to a discharge tundish, or in the event of leaks occurring at the hydraulic fittings. If this advice is not heeded, the manufacturer cannot be held responsible for any resulting damage.

In the event of a malfunction, fault or incorrect operation, the appliance should be deactivated; contact a qualified technician for assistance.

Hydraulic connections - reversibility

Installation of the SATK32 series heat interface unit is reversible (top-down). Installation in the two positions is possible with or without template code 789023.

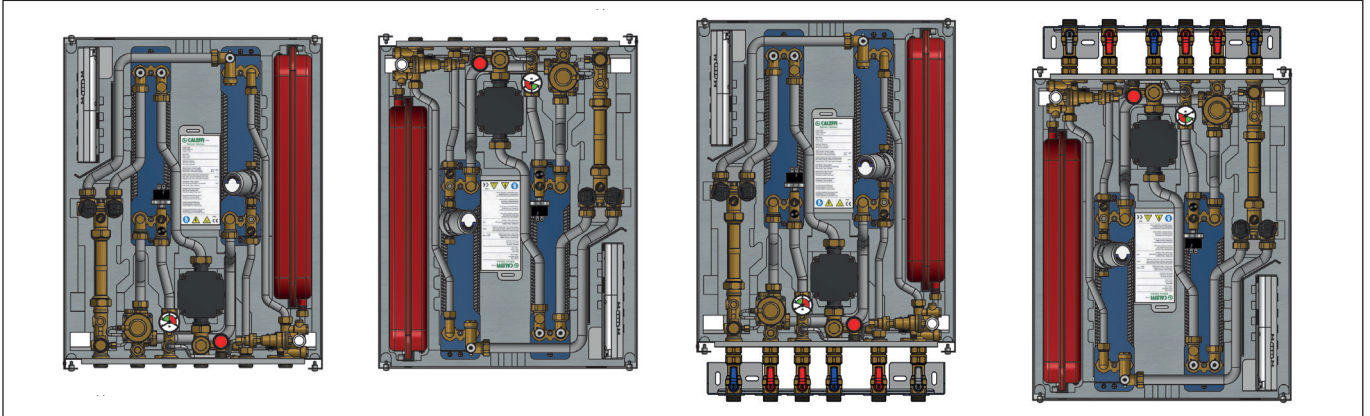

Charging unit

To install the charging unit with backflow preventer code 572120, proceed as follows:

- remove the nuts shown in the figure with letter "A";

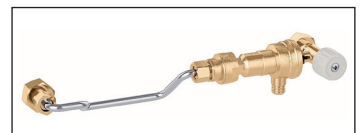
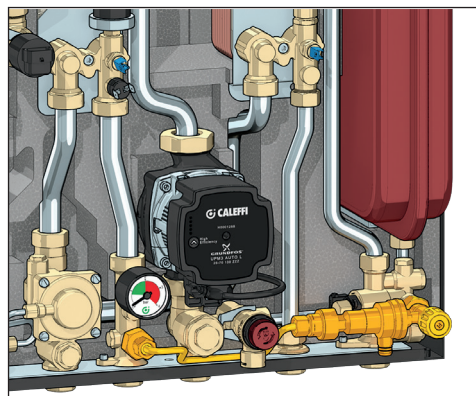
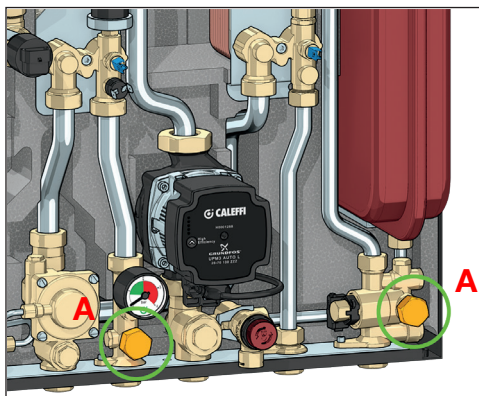

* Filling unit not used in the UK market.
For information on the user system filling procedure, please refer to the technical documentation for the product ALT-HIUFLP in compliance with regulation G24 PTII.

- Insert the charging unit as shown in the figure, using the supplied seals.

Preliminary operations - installation without template

After having established the point of installation of the appliance, perform the following operations:

- Mark the holes required for the bracket to secure the HIU to the wall
- Mark the position of the hydraulic connections

Check the measurements again and, based on the above connection diagram and the dimensions shown on page 3, proceed with the installation of the following lines:

• Hydraulic:

1. connection to the central system line
2. heating circuit connection
3. domestic water circuit connection
4. conveyance of safety relief valve and charging unit backflow preventer discharge

NOTE:

We recommend installing manual shut-off valves, especially on the connections to the primary line, thus allowing any necessary maintenance work to be carried out without having to empty the centralised system.

Before installation, it is recommended to carry out accurate flushing of all the pipes of the system in order to remove any residue or impurities that could endanger correct operation of the HIU.

In order to facilitate these operations a manual bypass flushing valve is available (code 789110).

Installation procedure (without template)

Secure the metal bracket supplied with the HIU to the wall using suitable wall anchors.

Connections on the bottom

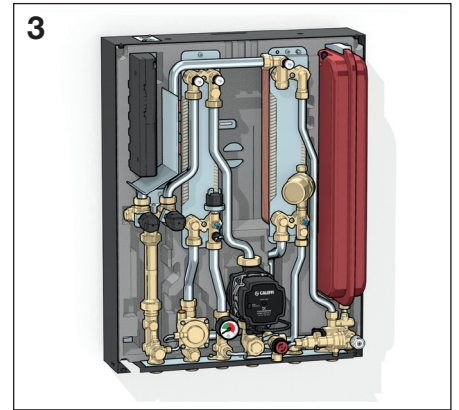
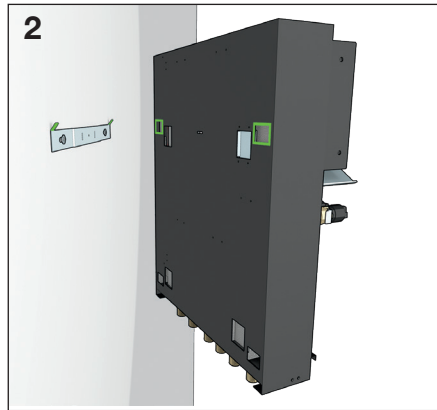
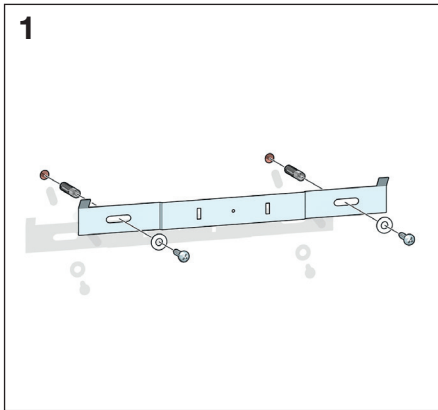

Connections on the top

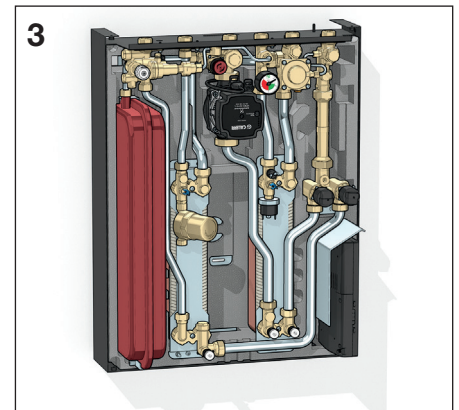
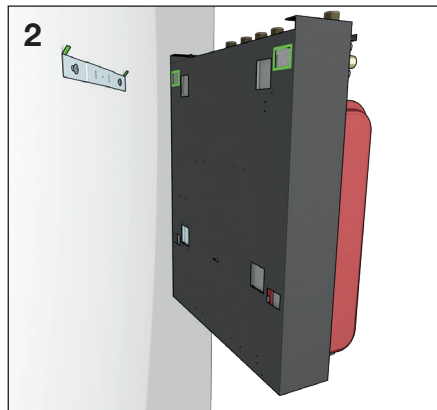
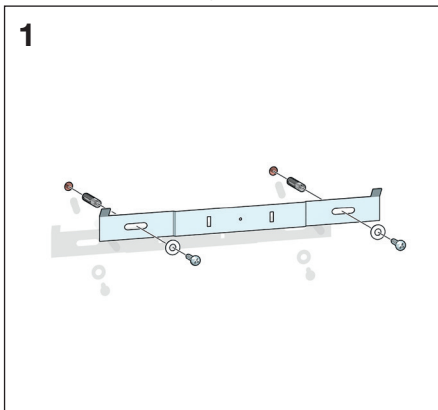

Installation with template

NOTE:

Before installation, it is recommended to carry out accurate flushing of all the pipes of the system in order to remove any residue or impurities that could endanger correct operation of the HIU.

In order to facilitate these operations a manual bypass flushing valve is available (code 789110).

Connections on the bottom

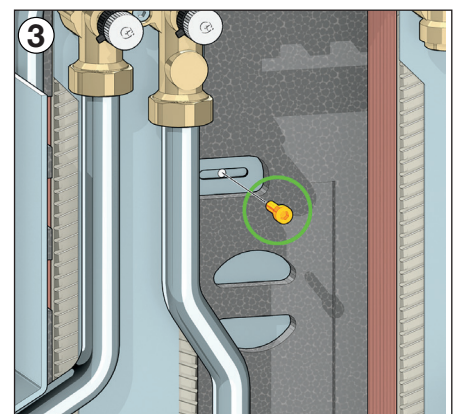
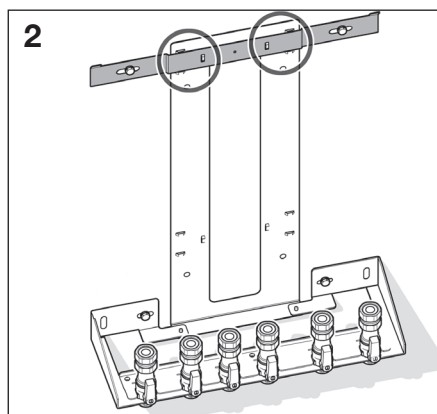
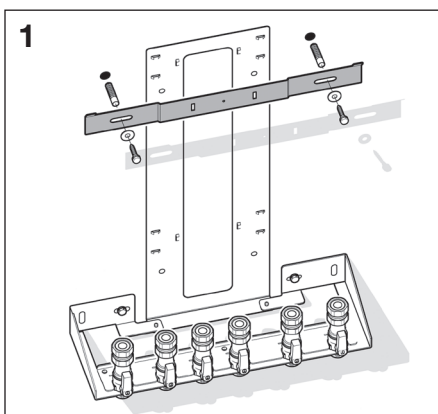

Connections on the top

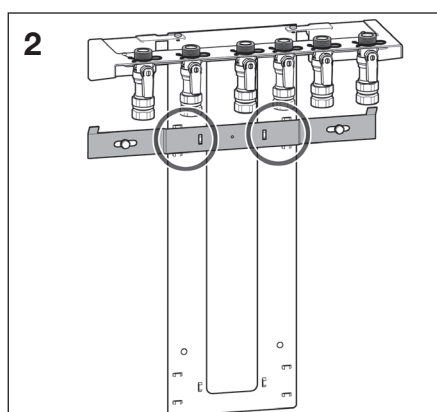
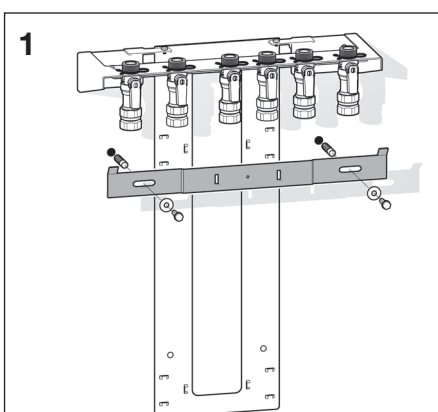

N.B.:
In the case of installation with connections on the bottom fit the safety screw (figure 3).

Install SATK32 as per the above pictures and close the 6 nuts using the fiber gaskets supplied.

Conveyance of the safety relief valve

The safety relief valve is equipped with a compression fitting suitable for 15 mm copper pipe and can be rotated in accordance with the HIU installation position. If SATK32 is installed with upward facing connections, use discharge pipe code 789832, specifically designed to route the valve drain line through the insulation shell, without damaging the internal electronic components.

Heat meter installation

The HIU is fitted to house a compact heat meter (with incorporated return probe) with 1" threaded connections and length of 130 mm.

Before carrying out any maintenance, repair or part replacement work, proceed as follows:

- cut off the electric supply
- remove the cover
- close the shut-off valves on the primary flow and return
- empty the HIU using the drain cocks provided
- remove the template (A)
- remove the cap (B)
- install the flow meter on the return pipe. To tighten the nuts apply maximum tightening torque of 25 Nm, taking account of the indications of the heat meter manufacturer.
- install the flow probe in the M10 pocket (B).

Please refer to the heat meter technical data sheets for further information.

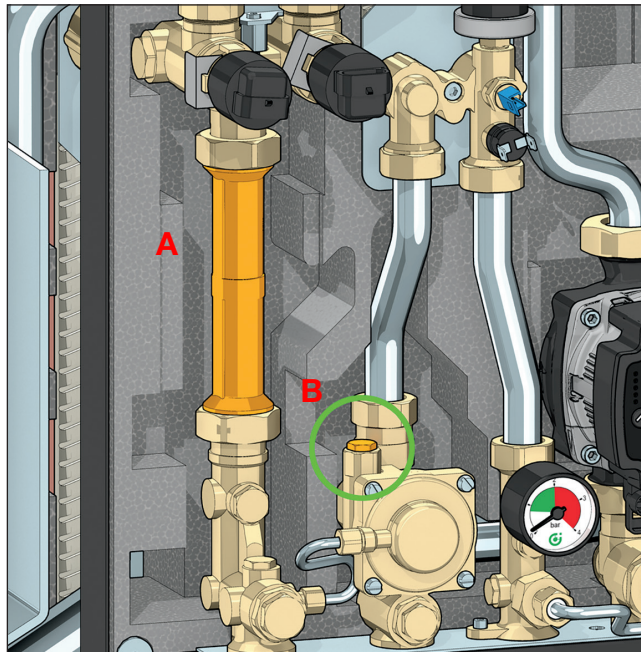

Electrical installation

Connection to the electric supply

The appliance is supplied with an electric supply cable which is not fitted with a plug.

The appliance should be electrically connected to a 230 V ~ (AC) single-phase + earth mains supply using the three-wire cable marked with the label as specified aside, observing the LIVE (L) - NEUTRAL (N) polarities and the earth connection. This line must be connected to a circuit breaker device.

To extend the cable if necessary, use a flexible cable suitable for kitchen and heating appliances and for home, kitchen and office installations, also in humid environments subject to medium levels of mechanical stress (e.g. H05V2V2-F: Uo/U 300/500 V). Cable minimum cross-section 3 x 0,75 mm².

Make sure that the electrical system can withstand the maximum power consumption of the appliance, with particular emphasis on the cross-section of the wires. If you have any doubts, contact a qualified technician to request a thorough check of the electrical system.

Electrical safety of the appliance is only achieved when it is correctly connected to an effective earthing system, constructed as specified in current safety regulations. This is a compulsory safety requirement.

Observe the applicable regulations in force in the country of installation.

Use the cable pathway provided, as shown in figure 1.

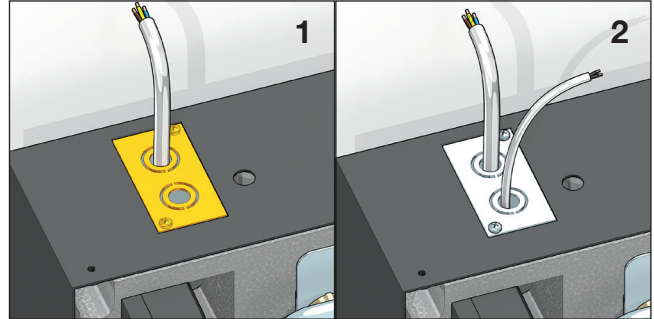
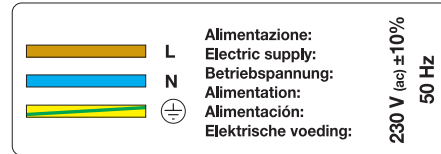

Optional electric connections

The controller has a door on the front providing access to terminal boards for optional wiring (see chapter "circuit board details"). The connections in question are all low voltage or potential-free. Any wiring must be directed toward the exterior of the HIU, using the pathways provided in the insulation and on the frame. All the low voltage lines must be routed through a single dedicated cable raceway, using the pathway that is not used for the electric supply cable (see figure 2), so that they are separate from the 230 V electric cables. Any other high voltage connection, e.g. the one from the auxiliary microswitch (see pages 13 and 16) must pass through the same cable pathway used for the main electric supply.

Remote user interface connection

The HIU user interface has the dual function of control device and room thermostat. The remote user interface can be installed on board the HIU or in the room in a position where the temperature measurements will be of significance for control of the heating function (in a heated room in a position where the temperature read by the thermostat is not affected by any nearby heat sources).

Installation on board the HIU

If the remote user interface is fitted in the dedicated location on the cover of the HIU, the thermostat function must be disabled (in this case an external thermostat must be used, as described in the next section). The adjacent figures show how to install the remote control unit:

- Feed the cable from the regulator through the hole in the cover (3);
- Feed the cable from the regulator through the rear of the interface (4);
- Connect the two wires to the terminals on the electronic circuit board (the cable is not polarised) (5);
- Close the interface and position it in its housing on the cover (6), (7);
- If necessary, secure the interface from inside the cover by means of the supplied pair of self tapping screws, spacers, and washers;
- Plug in the connector (8).

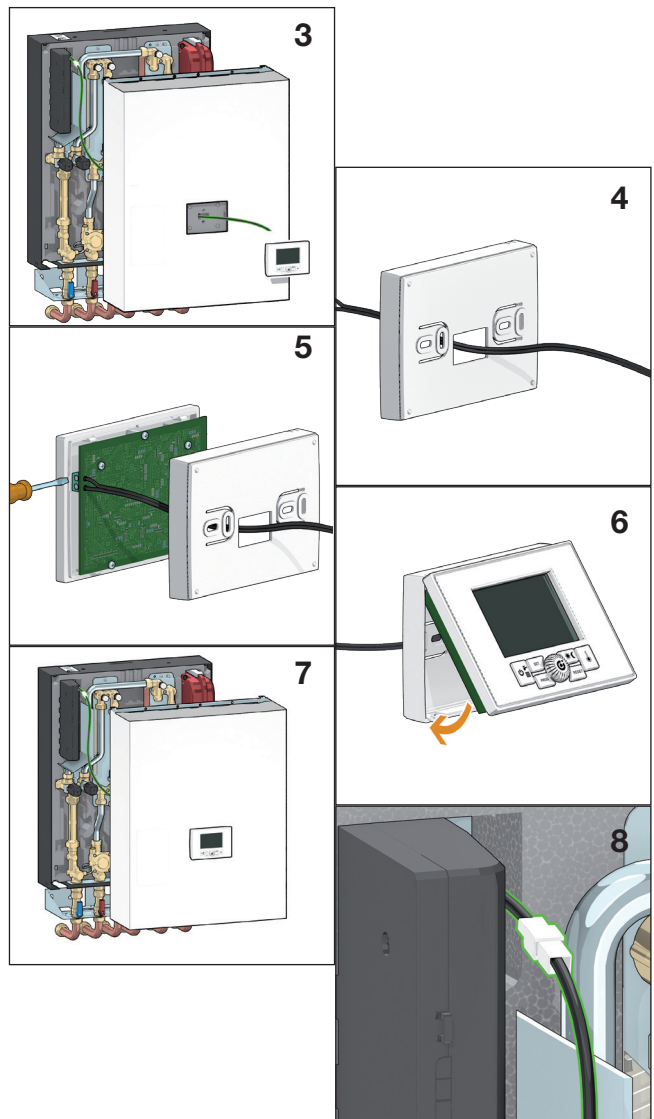

The thermostat function is enabled by default (refer to the remote control user manual for disabling it).

Installation in the room

Use the cable outlet provided for connection of the remote user interface to the electronic circuit board.

The chrono-thermostat function has to be enabled through the remote control. Refer to the dedicated user manual for the procedure.

Use of an external room thermostat

An external room thermostat, if installed, must necessarily be with **potential-free contact**.

The external thermostat has to be connected to the terminals "RT" shown in the adjacent figure. The terminals can be accessed by removing the door on the HIU electronic regulator (see page 19).

In case the thermostat function of the remote user interface is enabled, any external thermostat will work in parallel (management of different temperature zones). Alternatively, when the thermostat function of the remote user interface is disabled, the interface can be used to define the hourly programming of the space heating function for all thermostats connected to the terminals "RT".

Refer to the user interface dedicated manual.

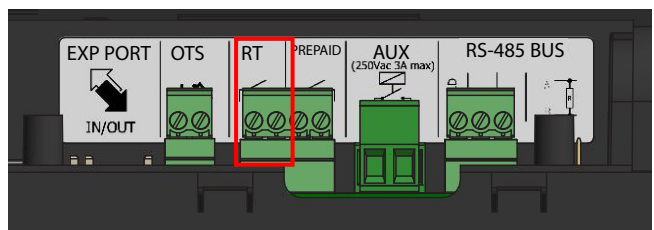

Commissioning

Filling procedure for SATK32 centralised system

1. Open the air vent cocks upstream of the DHW and HEAT regulating valves.

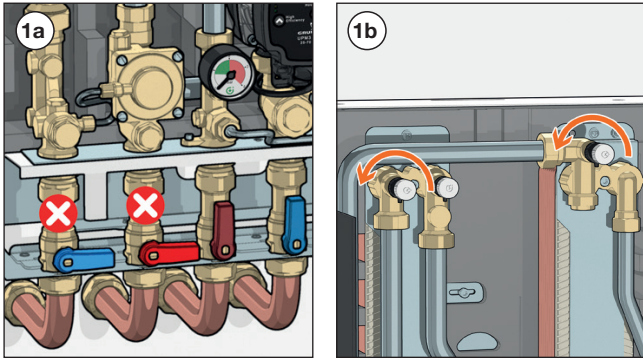

2. Slowly open the primary circuit flow shut-off valve at the HIU inlet. At this stage, shut off the air vent cocks when water begins to come out (fig. 2b).

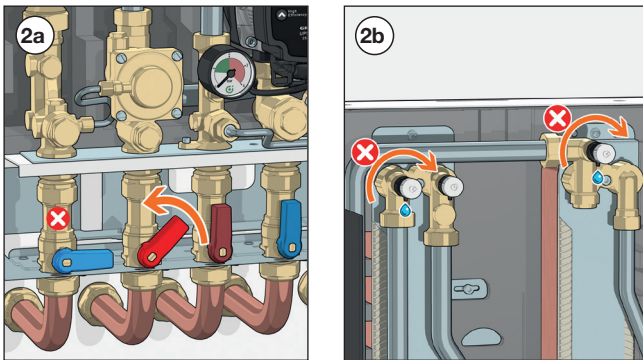

3. When filling is complete, slowly open the primary circuit shut-off valve at the HIU inlet until it is fully open.
4. Slowly open the primary circuit return shut-off valve at the HIU outlet.

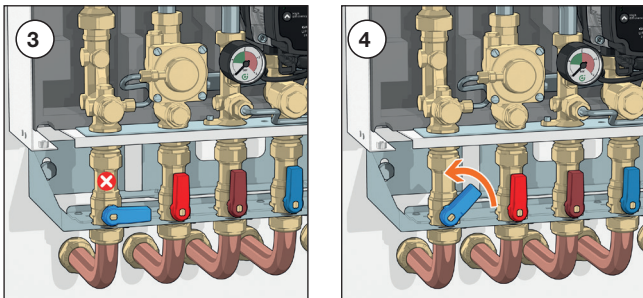

5. When filling is complete, slowly open the primary circuit return shut-off valve at the HIU outlet until it is fully open.

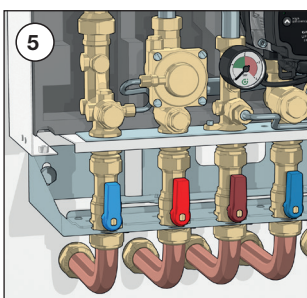

N.B. during the procedures for venting/draining the system use suitable measures to avoid the risk of any liquid dripping onto the electronic components.

Vessel pre-charge check

Perform the following steps:

- Use a pressure gauge to check the pre-charge value
- If necessary, restore the pre-charge value shown in the technical specifications.

Filling the user system

SATK32 series HIU can be fitted with a charging unit equipped with a backflow preventer (F), check valve (E) and cock (G) (code 572120). When filling the system for the first time or for subsequent top-up procedures following a heating circuit pressure switch fault, restore the system pressure (0,12–0,2 MPa - 1,2–2 bar) by opening cock (G) and checking the value by means of the pressure gauge (D). Once the correct pressure has been reached, close the cock (G), vent the system and re-check the pressure (repeat the filling process if necessary).

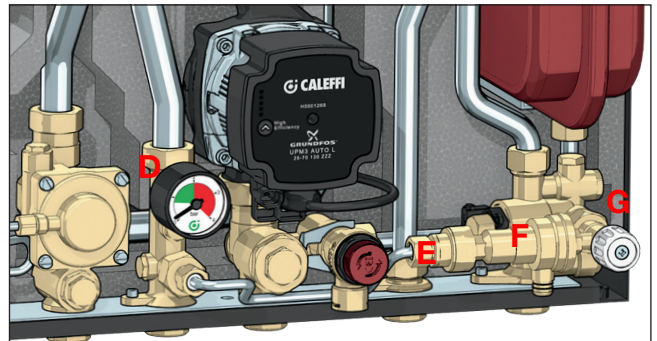

*** Filling unit not used in the UK market. For information on the user system filling procedure, please refer to the technical documentation for the product ALT-HIUFLP in compliance with regulation G24 PTII.**

System start-up

Before starting the HIU, visually check the hydraulic connections for the absence of any leakage and all the electric connections. After finishing the check, activate the electric supply to the HIU and check for the presence of any error signal.

If there is any, eliminate the fault indicated (see page 18) and proceed with setting the set point of the domestic water and heating cycles, programming the remote user interface according to the desired temperatures and times, and checking the operating cycles.

Fitting the cover

Fit the cover on the HIU by inserting the pins (A) in the locations provided (B).

Secure the cover by tightening the 4 screws provided (C).

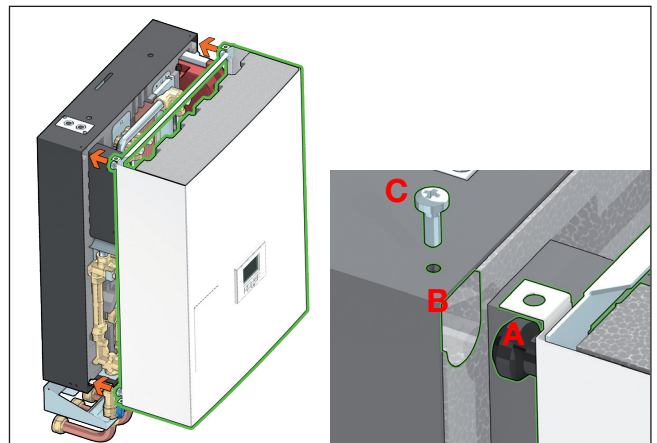

Remote user interface quick guide

DISPLAY:

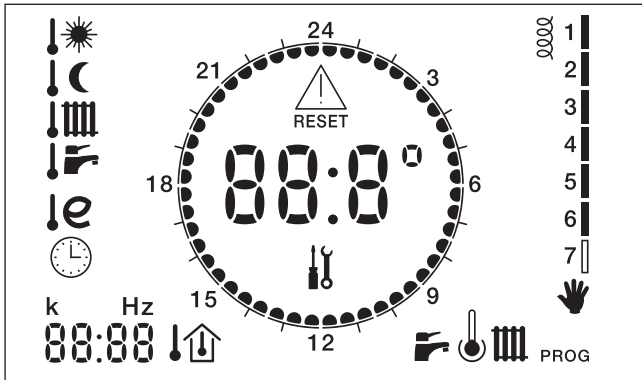

BUTTONS:

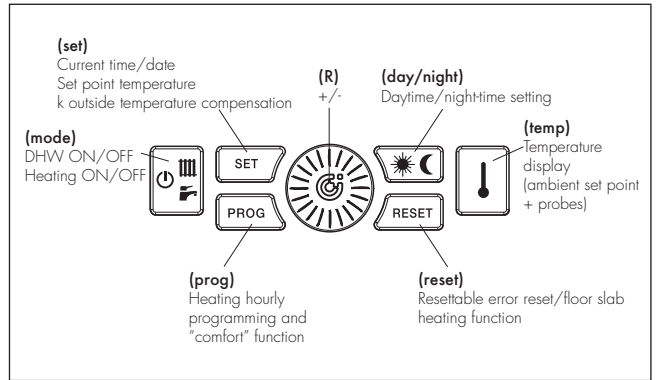

The digits in the center of the display show the current ambient temperature, if the thermostat function is enabled. In case the latter is disabled, the digits show DHW temperature and heating flow temperature when the HIU is in operation, "--." when in stand-by.

Selecting the active services (DHW/heating)

Press the <mode> key repeatedly to scroll through the various available operating modes.



OFF

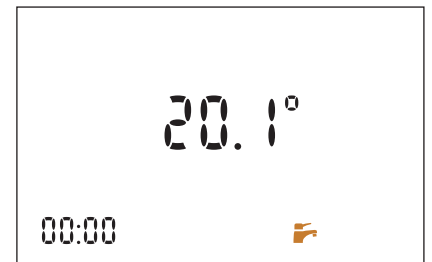

DHW only ("summer" mode)



Heating + DHW ("winter" mode)

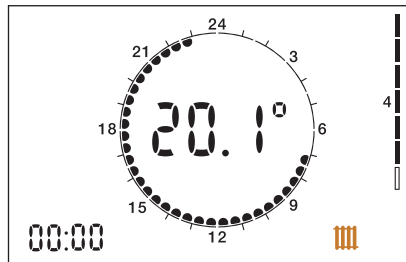

Heating only

Selecting set points, current time and comfort function

Press the <set> key repeatedly to set the current time, set point temperatures and comfort function. The value can be modified by turning knob <R>.

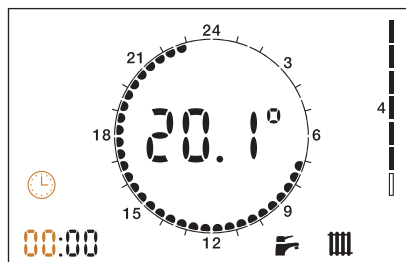

Current hours, minutes and day

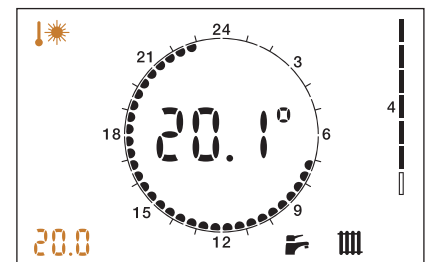

Daytime ambient temperature (*)

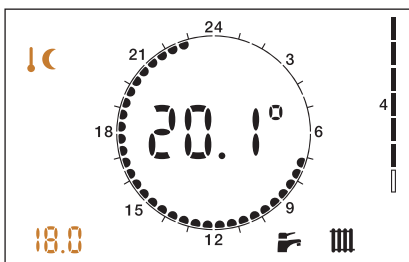

Night-time ambient temperature (*)



Heating flow temperature

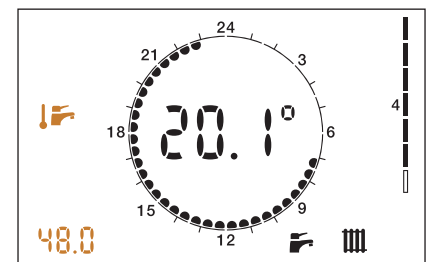

DHW temperature

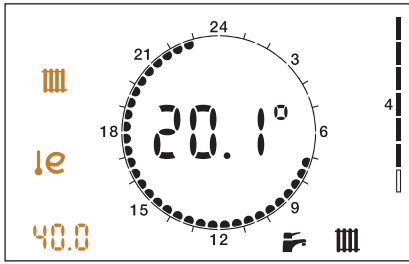

Primary limit/set return temperature in heating mode (**)

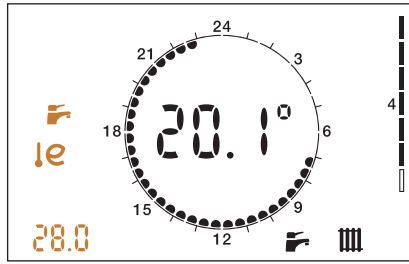

Primary limit/set return temperature in DHW mode (**)

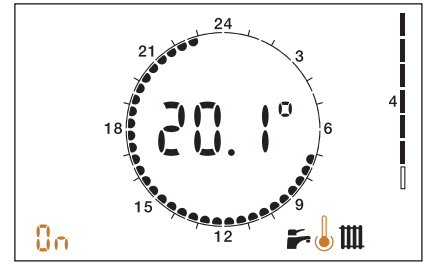

Comfort function (ON/OFF or according to weekly program) (see page 13)

(*) if the thermostat function of the remote user interface is enabled.

(**) if these set points cannot be changed you must set parameter t07 to value 0 in the technical menu (see "access to technical menu" below). Parameter t07= 1 "freezes" the operating set points to prevent inadvertent modifications by the user.

Temperature display

Press the <temp> key repeatedly to display the current ambient temperature set point and the temperature values read by the three probes of the HIU.

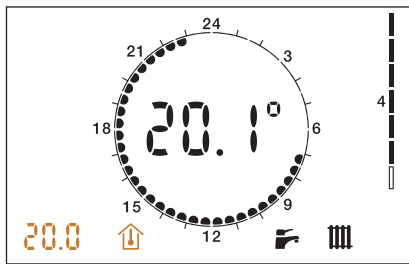

Current ambient temperature set point (*)

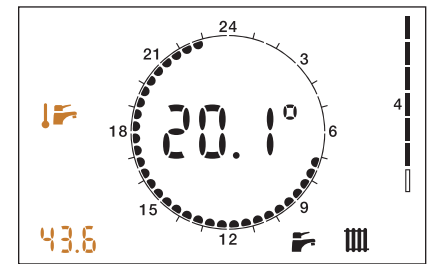

DHW probe temperature

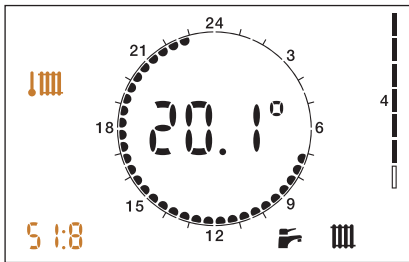

Heating flow probe temperature

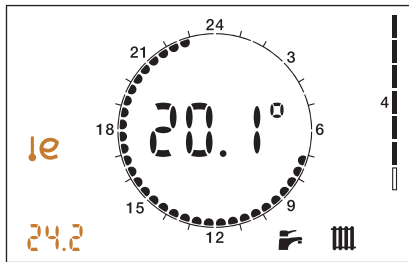

Primary return probe temperature

(*) if the thermostat function of the remote user interface is enabled.

Access to technical menu

Press the <mode> key repeatedly to set the HIU to OFF status.



Heat interface unit in OFF mode

Hold the <set>, <day/night> and <temp> keys pressed together for 10 seconds.

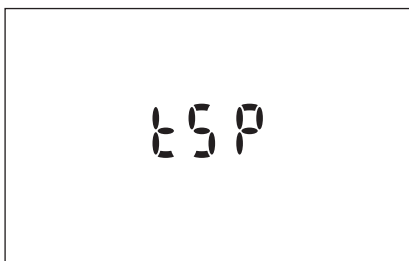

Access to the technical parameters

Once "TSP" appears on the display, confirm access by pressing the central knob <R>. By rotating knob <R> it is possible to scroll through the various parameters, which can then be edited, pressing and rotating knob <R>.



Technical parameter t00

To exit the menu, wait a few seconds or press the <reset> key. Re-enable the required services using the <mode> key.

Refer to the remote control user manual for the hourly programming of space heating and DHW comfort function.

Heating function

HIU setting at HIGH/LOW temperature

The HIU is set at LOW temperature by default (underfloor heating, parameter t00 = 1). To change this setting and supply a system with high temperature terminals go to the technical menu (see page 11) and set parameter t00 to 0.

DEFAULT SETTING: set point regulation (technical parameter t01 = 0)

When heating cycle activation is requested by the room thermostat, the circulation pump is powered while the modulating valve is opened gradually until the set point temperature is reached.

The circulation pump is stopped and the modulating valve is closed at the end of the heating cycle. The heating cycle ON condition is indicated by the blinking  symbol.

OPTIONAL SETTING: primary return temperature limit (technical parameter t01 = 1)

When heating cycle activation is requested by the room thermostat, the circulation pump is powered while the modulating valve is opened gradually until the set point temperature is reached, if the return temperature is lower than or equal to the set limit value. In case this condition is not met, the flow temperature is reduced (by a maximum of 15°C for HIU in HIGH temperature, and maximum 3 °C if in LOW temperature), in order to bring return temperature within the limit values. When the flow temperature must be reduced in order to limit return, the  icon appears on the display.

Heating flow/ primary return limit temperature setting

To set the flow temperature press the <SET> key until the symbol in the red circle appears; for the return temperature limit press the key until the symbols in the green circle are displayed. Use the <R> knob to change the value (*).

The flow temperature range is:

25–45 °C for heat interface units in LOW temperature

45–75 °C for heat interface units in HIGH temperature

The primary return limit temperature range is:

15–42 °C for heat interface units in LOW temperature

30–70 °C for heat interface units in HIGH temperature

OPTIONAL SETTING: modulating temperature regulation with compensated set point (technical parameter t01= 2)

When the function is enabled, the flow temperature is modified (± 10 °C with respect to the set point for HIU in HIGH temperature, ± 3 °C if in LOW temperature) according to the temperature detected by the return probe in order to maintain this latter temperature value constant. This keeps the actual thermal output of the slab under control, and consequently also the ambient thermal load. The thermal response time of the system is thus minimised.

This feature should not be used in combination with thermostatic radiator valves.

When the function is enabled the display shows the symbol .

OPTIONAL SETTING: weather compensation (technical parameter t01 = 3)

When the function is enabled, the flow temperature is calculated based on the temperature detected by the outside probe (optional), in accordance with the curve shown below. The “k” coefficient can be changed by pressing <SET> button until the related setting appears.

The display shows the symbol .

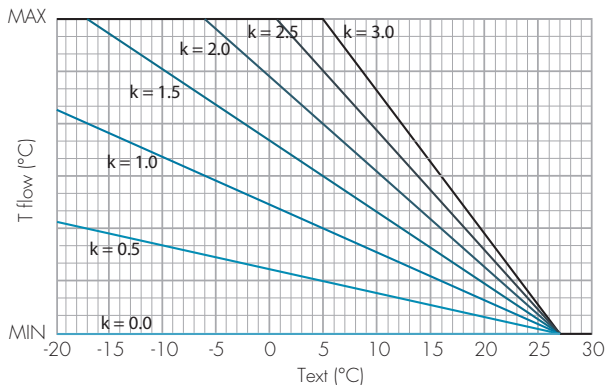

MAX is the set temperature value
MIN is 45 °C for HIGH temp. HIUs, 25 °C for LOW temp. ones.

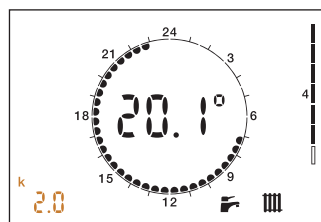
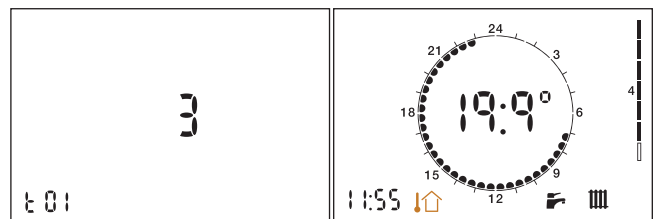
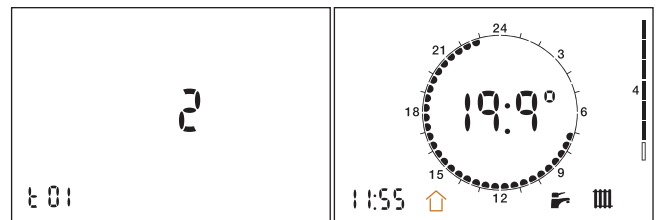
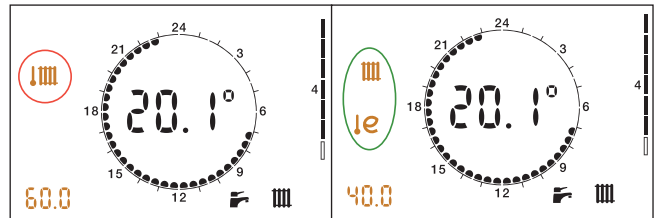
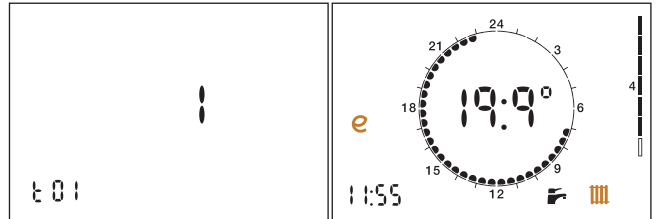
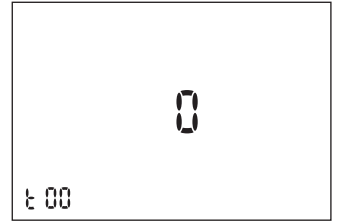

(* if these set points cannot be changed you must set parameter t07 to value 0 in the technical menu (see “access to technical menu” below). Parameter t07 = 1 “freezes” the operating set points to prevent inadvertent modifications by the user.

DHW function

The DHW cycle always takes priority over the heating cycle.

DEFAULT SETTING: fixed DHW set point (parameter t06=0)

When DHW cycle activation is requested, due to DHW tapping by the user (detected by the domestic water flow meter), the regulator modulates the valve opening in order to adjust the temperature detected by the domestic water probe to the selected set point value. When tapping ends, the modulating valve is fully closed. The DHW cycle ON condition is indicated by the blinking  symbol.

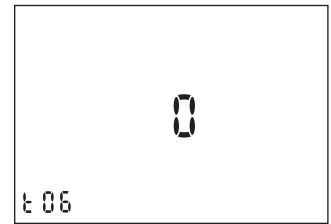

OPTIONAL SETTING: primary return temperature limit (technical parameter t06 = 1)

When DHW cycle activation is requested, due to DHW tapping by the user (detected by the domestic water flow meter), the regulator modulates the valve opening in order to adjust the temperature detected by the domestic water probe to the DHW set point value if the return temperature is less than or equal to the set limit. If this condition is not met, the flow temperature is reduced (by a maximum of 7 °C down to a temperature that can be no less than 40 °C), in order to bring return temperature within the limit values.

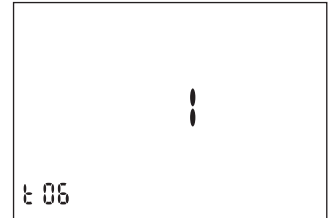

Due to the activation of the return temperature limitation function, DHW temperature can be lower than the set value.

DHW/primary return limit temperature setting

To set the DHW temperature press the <SET> key until the symbol in the red circle appears; for the return temperature limit press the key until the symbols in the green circle are displayed. Use the <R> knob to change the value (*).

The range of possible DHW temperatures is 42–60 °C, while the range of possible return temperatures is 15–45 °C.

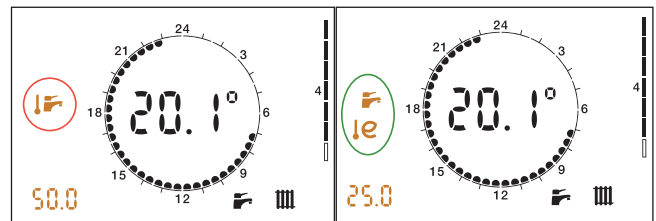

(* if these set points cannot be changed you must set parameter t07 to value 0 in the technical menu (see “access to technical menu” below). Parameter t07 = 1 “freezes” the operating set points to prevent inadvertent modifications by the user.

DHW Comfort functions (pre-heating, DHW recirculation)

The comfort function can be, alternatively, preheating of the DHW plate heat exchanger or management of DHW recirculation. They are enabled by setting to ON or PROG the comfort function (see page 11).

DEFAULT SETTING: DHW exchanger preheating function (parameter t02 = 0)

During periods when the domestic water cycle is not used, if the DHW probe detects a temperature 10 °C below the SET value, the regulator partially opens the domestic hot water modulating valve for the time required (max. 5 min.) to bring the exchanger to the condition wherein it can assure rapid DHW production.

The active pre-heating cycle is indicated by the blinking  symbol.

This function is of lower priority than any domestic water or heating cycles.

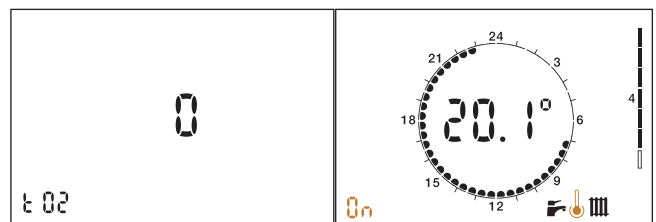

OPTIONAL SETTING: management of DHW recirculation in the apartment (parameter t02 = 1)

In alternative to the DHW comfort function it is possible to manage DHW recirculation, using a similar logic. During periods when the domestic water cycle is not used, if the DHW probe detects a temperature 10 °C below the SET value, by means of an auxiliary microswitch (see page 19), the regulator closes the circuit supplying the circulation pump (not supplied) generating a DHW cycle lasting for a pre-set amount of time. This amount of time is pre-set to 2 minutes. It can be changed by acting on parameter t09 on the technical menu (1 unit = 10 seconds).

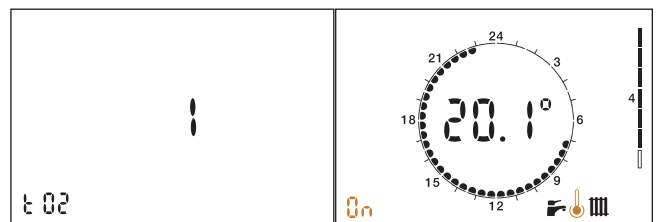

The circulator has to be fed through the auxiliary microswitch so that the control of recirculation is carried out by the heat interface unit. DHW recirculation (t02=1) disables the other functions operating on the auxiliary microswitch described on page 16. Refer to page 16 for the electrical characteristics of the microswitch.

Both comfort functions can be enabled according to user defined weekly time programming. Refer to the remote user interface manual.

N.B.: In the presence of a DHW recirculation system a suitably sized expansion vessel must be installed.

Anti-legionella function

DEFAULT SETTING: anti-legionella function OFF
(technical parameter t08 = 0)

Enabling the anti-legionella function by means of technical parameter t08 = 1, in time band 3:00 - 3:30:

- the DHW set point will be temporarily increased to the maximum value (60 °C) - the comfort/recirculation function will be forced ON.

As a result of the temperature rise of the set point, at time 3:00 a comfort function (either pre-heating or recirculation) will be triggered, bringing the temperature to a value close to 60 °C, such as to rapidly reduce the presence of any bacteria.

During execution of the cycle, the user interface display will show the blinking  symbol (refer to the adjacent figure).

IMPORTANT!

- Any DHW production that occurs during the time band (3:00 - 3:30) will be at 60 °C.
- The cycle execution time band (3:00 - 3:30) is established in accordance with the time set on the remote control unit. Incorrect time setting will result in execution of the anti-legionella function in a different actual time band.
Due to the effect of exchanger thermal inertia, temporary DHW production at high temperature could proceed also beyond the time of 3:30.

If the function is enabled thermostatic mixing valves should be installed on the users level (washbasin/shower, etc.).

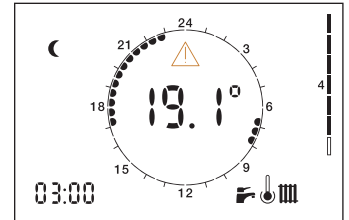
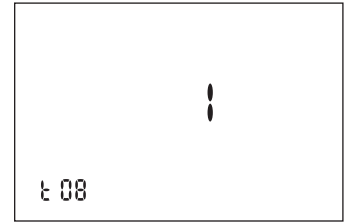

Primary flow rate limitation

Primary flow rate limitation in heating mode

DEFAULT SETTING: no limitation (technical parameter t03 = 100)

During start-up of the heating cycle from cold, e.g. on changeover from night-time ambient set point to the daytime set point, the HIU may demand a significantly higher primary flow rate than the design one, because of the low temperatures of the secondary medium. This effect is far greater with high temperature systems in which, during the transient to the design operating condition, high thermal power values may be transferred from the primary circuit to the secondary circuit. This effect can be restricted by lengthening the transient, setting a limit on the maximum primary flow rate that can be withdrawn in heating mode.

The flow rate limitation is imposed by controlling the maximum opening of the primary circuit modulating valve. Since latter is controlled by a differential pressure limiter, it is possible to supply direct correspondence between the opening position of the valve and the circulating flow rate (*)

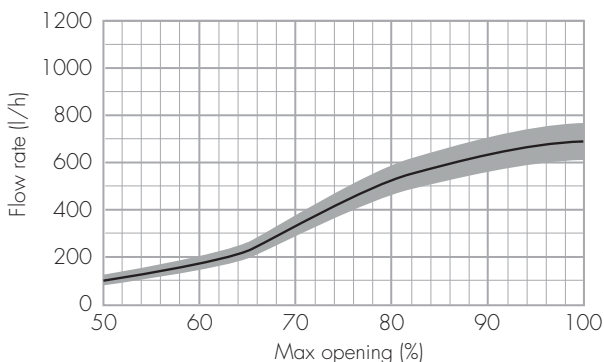

A maximum degree of opening (%) can be set via technical menu parameter t03.

Primary flow rate limitation in DHW mode

DEFAULT SETTING: no limitation (technical parameter t04 = 100)

Likewise, you can establish a limit to the primary flow rate that can be tapped for instantaneous DHW production.

The flow rate limitation is imposed by controlling the maximum opening of the primary circuit modulating valve. Since latter is controlled by a differential pressure limiter, it is possible to supply direct correspondence between the opening position of the valve and the circulating flow rate (*)

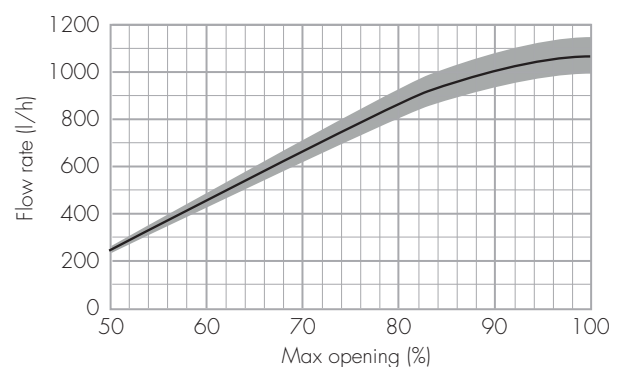

A maximum degree of opening (%) can be set via technical menu parameter t04.

N.B. Any limitation must be assessed in accordance with the effective thermal characteristics of the residential unit served.

(*) The correspondence between valve position and flow rate is indicative. Graphs obtained with pressure head upstream of the HIU = 50 kPa.

Circulator - Curves and setting

The HIU is equipped with a Grundfos circulator model UPM3 AUTO 15-70.

By default, the circulator setting is with the maximum proportional head characteristic.

To change the characteristic, hold down the front key for more than two seconds and then press the same key repeatedly until reaching the required characteristic (refer to the figure below).

Having identified the required characteristic (head - flow rate chart shown below) wait for about ten seconds for the setting to be accepted by the circulator, which will then revert to the sequence of LEDs showing power consumption.

A long press of the front key (>10 s) locks the pump setting, preventing possible incorrect modifications of the curve. Unlocking can be done in the same way, with a long press (>10 s) of the front key.

The pump also has a self-diagnostics system to reveal any possible operating problems.

Any problem detected is shown by a sequence of LEDs:

ALARM STATUS					
●	●	●	●	●	Blocked
●	●	●	●	●	Supply voltage low
●	●	●	●	●	Electrical error

➤	LED SEQUENCE	CURVE TYPE	➤
0	● ● ● ● ●	PROPORTIONAL AUTO ADAPT	➤
1	● ● ● ● ●	CONSTANT AUTO ADAPT	➤
2	● ● ● ● ●	PROPORTIONAL 1	➤
3	● ● ● ● ●	PROPORTIONAL 2	➤
4	● ● ● ● ●	PROPORTIONAL 3 - MAX	➤
5	● ● ● ● ●	CONSTANT 1	➤
6	● ● ● ● ●	CONSTANT 2	➤
7	● ● ● ● ●	CONSTANT 3 - MAX	➤
8	● ● ● ● ●	FIXED SPEED 1	➤
9	● ● ● ● ●	FIXED SPEED 2	➤
10	● ● ● ● ●	FIXED SPEED 3 - MAX	➤

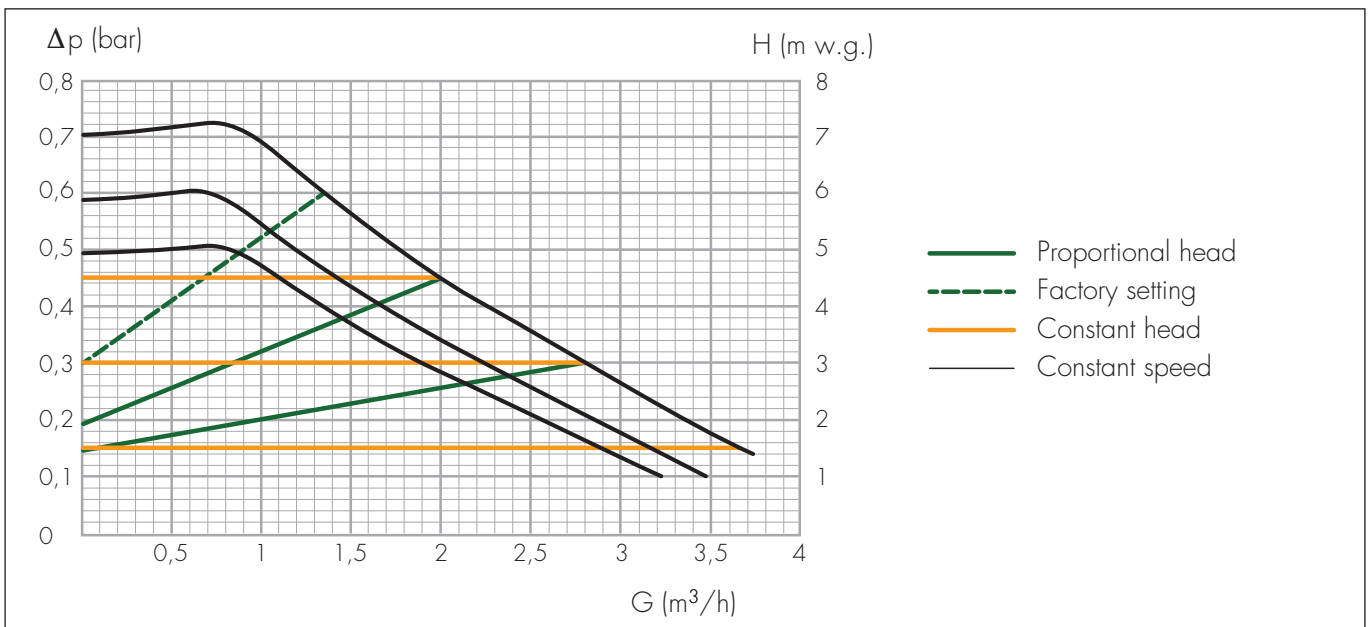

Auxiliary microswitch

The HIU is equipped with a contact, driven by a relay incorporated in the circuit board, the intervention logic of which can be programmed in accordance with requirements by setting technical parameter t05.

Each event linked to operation of the HIU is linked to a numerical value, according to the following table:

Event/condition	Value
DHW tapping in progress	1
Heating cycle in progress	2
Comfort cycle (pre-heating/recirculation) in progress	4
HIU OFF	8
Error not active	16
Error active	32

Closing of the contact on the occurrence of multiple events conditions is programmed by setting parameter t05 to a value corresponding to the sum of the single events/conditions.

We give some practical examples below:

example 1 - Driving an external primary flow pump, normally OFF.

The contact must be closed if any HIU function is active (DHW production, heating, pre-heating)

Parameter t05 must be set to: $1 + 2 + 4 = 7$

This value (t05 = 7) is **set by default**.

example 2 - Distinction of consumption for DHW production from total consumption (in combination with heat meter equipped with dedicated function)

The contact must be closed both if DHW tapping is in progress and if activation of the comfort function is requested (pre-heating or recirculation).

Parameter t05 must be set to $1 + 4 = 5$.

Closing of the microswitch is shown on the user interface by the symbols shown alongside.

N.B. if the DHW recirculation function is enabled with t02 = 1 (see page 13) the auxiliary microswitch intervention logic described above is not operational. In this case, the contact is used to control the recirculation pump.

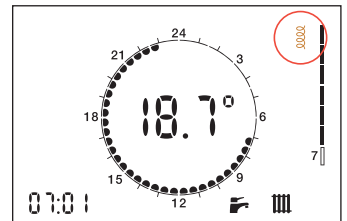
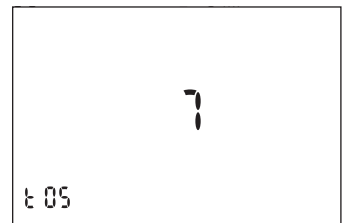

Connection

For information on how to access the dedicated terminals, consult the "auxiliary microswitch" section on page 19.

N.B.: the auxiliary microswitch can be used to drive electric loads directly, taking account of the following operating limits:

- Max voltage: 230 V ~ (AC)
- Max current: 3 A

If the electric load to be controlled is not included within the parameters indicated an external relay must be interposed.

Modbus

The HIU offers a remote connectivity solution by means an RS-485 wired network and Modbus RTU communication protocol.

On request, Caleffi will supply a map of the Mod-Bus registers and data transmission specifications so the product can be integrated in an existing BMS system.

The RS-485 communication network should be preferably constructed in compliance with the prescriptions of standard EIA RS-485.

Any other configuration of the physical layer is at the discretion of the BMS system operator, which will assume responsibility for checking the implications in terms of transmission quality.

In particular, it is essential to use a two-wire twisted cable. Compliance with this requirement becomes even more significant the more extensive the RS-485 network.

If, alternatively, a shielded wire is used, the shield must be connected solely on the master side.

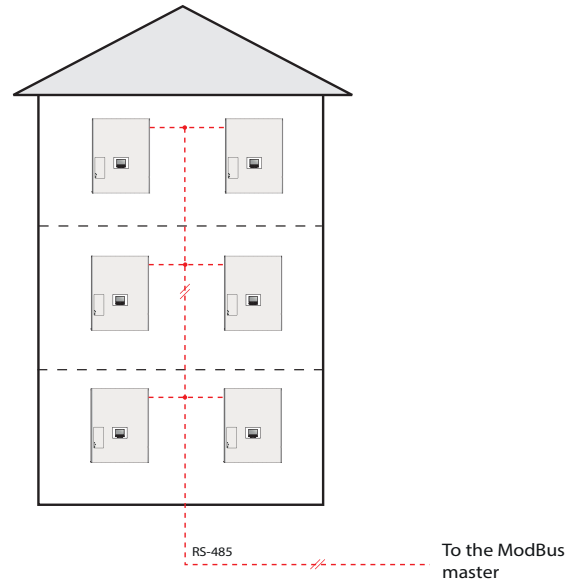

As a guideline, take account of the following general prescriptions to ensure optimal transmission quality:

- use a BUS cable with impedance of around 120 Ohm;
- connect a terminal resistor, having same impedance as the cable, at each end of the RS-485 cable;
- keep the length of side branches as short as possible.

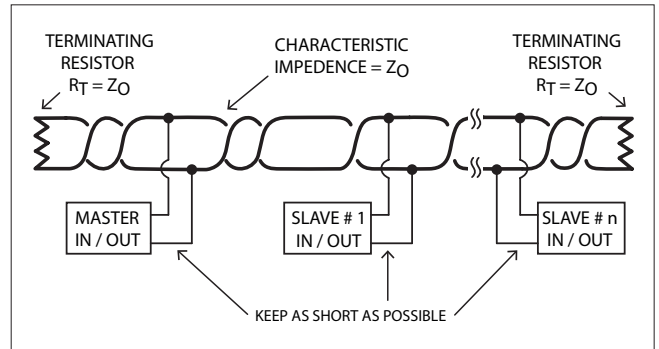

The device is configured by default to support a communication speed of 9600 baud/s with parity "none".

The communication speed can be changed via Modbus, to the following values: 2400, 4800, 9600, 19200 baud/s.

Safety and alarms

If the electronic circuit board detects a fault, the display shows the error code concerned and the symbol .

Heating circuit pressure switch fault Error code 4



The electronic regulator continuously monitors the status of the pressure switch controlling the water pressure in the heating circuit. If the pressure switch trips, the heating circulation pump immediately comes to a stop and the modulating valve is completely closed. This fault implies the stoppage of the heating cycle only. Domestic water drawing requests will continue to be served normally. **N.B.:** A low pre-charge value of the expansion vessel can cause a pressure switch fault.

Corrective action

Return to the operating mode is subordinate to restoration of the correct water pressure in the secondary heating circuit (see page 9 - "Filling the user system").

Probe fault

If a temperature probe fails, the associated cycle will be stopped immediately and disabled. Any requests to run cycles not associated to the previous one will continue to run normally.

Heating flow probe fault Error code: 5



Domestic hot water probe fault Error code: 6



Return probe fault Error code: 15



External temperature fault Error code: 38



Corrective action

Normal operating conditions are restored automatically once the faulty probe is working properly again (see page 20 - "Temperature probe replacement").

Safety thermostat cut-out Error code 69



HIUs configured to support low temperature heating continuously monitor the safety thermostat controlling the flow temperature. If the safety thermostat is activated during a general cycle, the heating circulation pump immediately comes to a stop and the modulating valve is completely closed. After the user has removed the block imposed by the safety thermostat, operation can only be re-enabled when the modulating valves are completely closed again. This means that if a domestic water cycle is in progress, the activation of the shut-off valve will be postponed until the end of that domestic water cycle.

Corrective action

To restore the operating mode press the manual RESET button.



Heat interface unit disabled Error code 80



The HIU is disabled due to an incorrect connection on the circuit board front terminals or due to an input from an external device indicating zero credit.

Corrective action

Check the electrical connections or, in the case of zero credit, top-up the external device/contact the service supplier.

Electronic circuit board

Optional connections

The electronic circuit board has a front door (shown in the adjacent figure) that provides access to the connectors related to HIU optional functions.

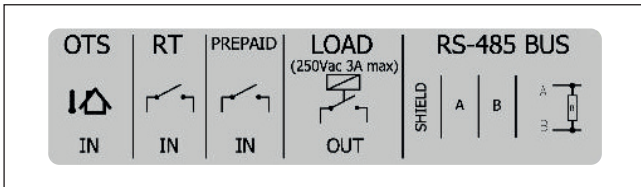

N.B. before working on the circuit board you must disconnect the electric supply to the HIU.

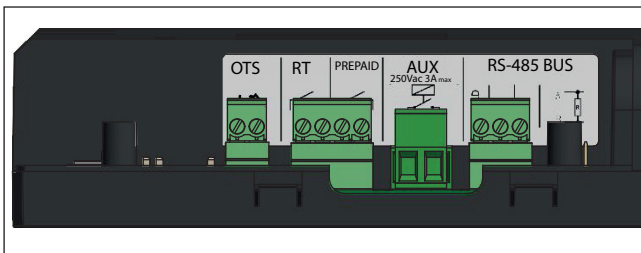

All the terminals are mounted on removable connectors to facilitate wiring operations.

The following services are accessible:

- **External probe for outside compensated temperature regulation**

Use optional probe code 789833



- **External room thermostat**

IMPORTANT! The connection is volt free. Do not connect powered contacts.



- **Interface with pre-paid services**

In case the HIU has to be interfaced with controllers managing the heating and DHW production services by means of "pre-paid" type logic. The HIU interprets an open contact as "credit available". Closing the contact disables the heating and DHW production services. When this condition occurs the user interface display shows error "E80".

IMPORTANT! The connection is volt free. Do not connect powered contacts.

If the controller that manages the pre-paid service supplies a powered contact, a relay must be interposed.



- **Auxiliary contact**

To implement the functions described on page 16 and for the connection of the DHW recirculation pump (see page 13)

IMPORTANT! Max voltage 230 V ac, max current 3 A.



- **Mod-Bus**

RS-485 port to connect HIU to a wired network for Mod-Bus communication.

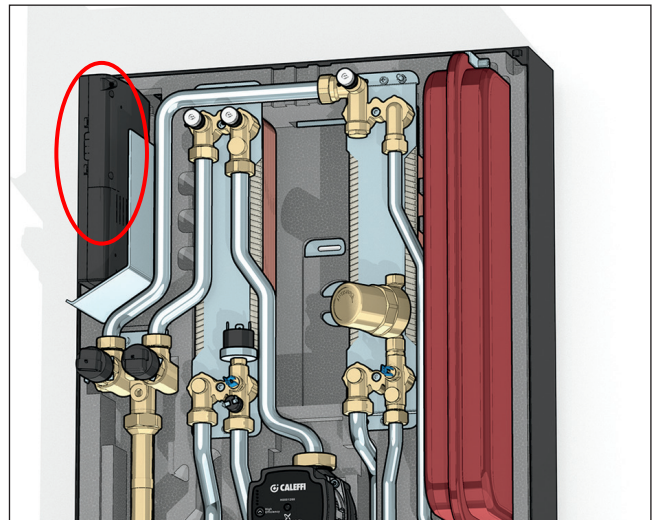
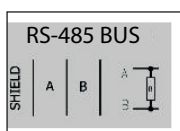

Connector colours

If the connectors of actuators and temperature probes are disconnected during special maintenance work, comply with the following instructions to reconnect them:

DHW probe:

Return probe:

Heating probe:

Heating valve actuator connector:

DHW valve actuator connector:

Pressure switch:

Safety thermostat:

Other electronic regulator functions

- **Reset diverter/modulating valve to zero**

Immediately after the power supply has been switched on, the position of the modulating valves is reset to zero.

- **Pump anti-seizing**

When the pump is not in use, it is powered on for a period of 5 seconds every 24 hours.

- **Diverter/modulating valve anti-seizing cycle**

The anti-seizing cycle for the diverter/modulating valve is run every 24 hours.

Periodic maintenance

The following checks must be carried out at least once every 12 months, in accordance with the prescriptions of standard EN 806-5.

OPERATIONS TO BE PERFORMED
Force an actuators reset by switching the HIU power supply OFF and then ON
Visually check for the absence of leaks and/or anomalies
Check for possible active errors shown on the user interface
Test correct operation of the pump by closing the thermostat contact or forcing it to close
Clean the strainers: on the primary flow line (component 17, page 4), on the secondary return line (19), upstream of the domestic water flow meter (22)
After having isolated the HIU by means of shut-off valves, discharge the pressure in the secondary circuit and make sure the expansion vessel pre-charge value is between 0.9 and 1.2 bar. Restore the pressure value, if necessary
Re-open the shut-off valves and restore secondary circuit pressure to a value between 1.3 and 1.7 bar
Check for the absence of any liquid dripping from the safety relief valve and ensure the drain is unobstructed
Check for the absence of internal leakage through the modulating valves when none of the services are active
Check correct setting of the set points (DHW and heating). Unless explicitly requested by the user or for normative reasons, a DHW temperature set point of 50 °C or lower is recommended
With the primary circuit at working temperature, check that the DHW flow rate at the correct temperature is sufficient

Summary of the technical parameters

Here follows a summary of the meaning and possible settings of the technical parameters:

Parameter	Meaning	Settings
t00	Temperature range of the HIU	0 = 45 - 75 °C 1 = 25 - 45 °C
t01	Heating flow temperature control	0 = fixed set point 1 = fixed set point with RTL 2 = compensated on return temperature 3 = weather compensated
t02	DHW comfort mode	From 0 = pre-heating of the heat exchanger 1 = DHW recirculation
t03	Maximum % opening of the heating modulating valve	From 50 to 100
t04	Maximum % opening of the DHW modulating valve	From 50 to 100
t05	Configuration of the closing logic of the auxiliary microswitch	See page 16
t06	DHW temperature control	0 = fixed set point 1 = fixed set point with RTL
t07	Freezing of some settings	0 = All temperature settings can be modified 1 = Return temperature limits are frozen
t08	Anti-legionella	0 = disabled 1 = enabled between 3:00 to 3:30 a.m.
t09	Duration of a DHW recirculation cycle	1 unit = 10 seconds

Maintenance

All maintenance procedures should be carried out by an authorised technician. Regular maintenance guarantees better efficiency and helps to save energy. Before carrying out any maintenance, repair or part replacement work, proceed as follows:

- Cut off the electric supply
- Remove the cover
- Close the shut-off valves
- Empty the heat interface unit using the drain cocks provided.

Exchanger replacement

- As a preliminary step, remove the flow sensor (refer to “replacing the DHW priority flow meter”, on page 21) and position it where it cannot be reached by any dripping liquid.
- Remove the exchanger, loosening the 2 hex socket head screws fixing it in place (A)
- Replace the exchanger and the O-rings.
- Tighten the two fixing screws (A) after having checked that the O-rings are correctly positioned. Tightening torque 3-3,5 Nm.

N.B. Make sure to respect the correct orientation of the plate heat exchanger when fitting it back.

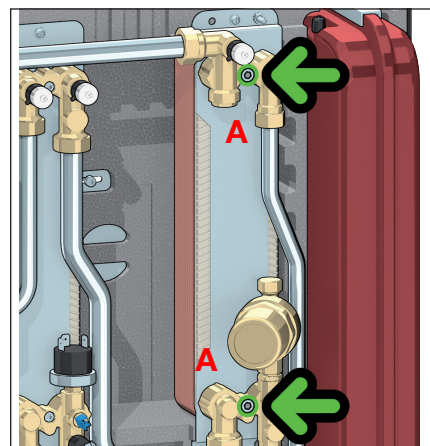

Cleaning the HIU primary circuit strainer

All heat interface units have a strainer on the inlet for water from the centralised system.

To clean these strainers, carry out the following maintenance procedure:

- Unscrew the cap (B)
- Remove the strainer mesh and discard any impurities it contains
- Refit the strainer mesh
- Refit the cap and tighten it.

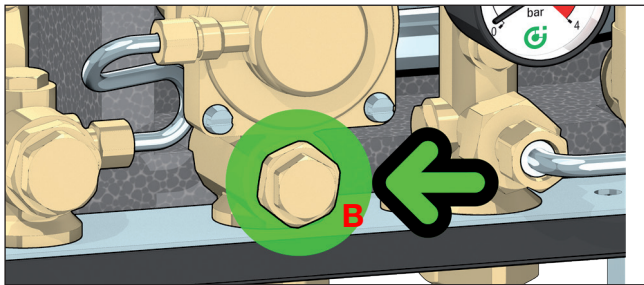

Temperature probe replacement

- Disconnect the probe cable by bending tab (C) slightly and extracting the connector.
- Unscrew the probe
- Fit the new probe
- Reconnect the connector respecting the only possible way it can be inserted.

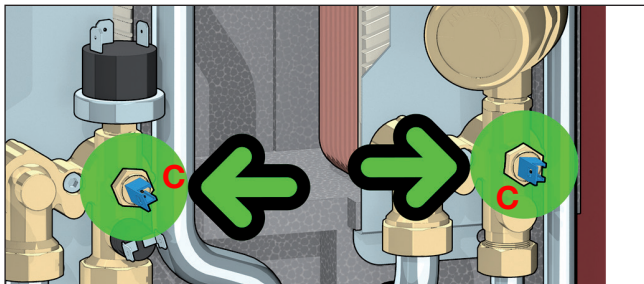

Replacing the actuator

- Extract the fixing clip (D) and then the actuator
- Position the new actuator (E)
- Insert the fixing clip, respecting the correct direction
- Reconnect the connector.

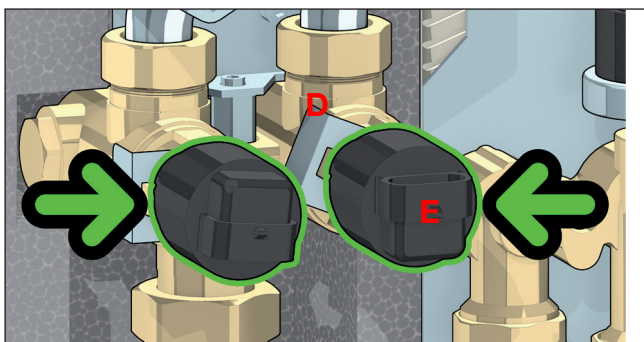

Replacing the valve obturator

- Disconnect the valve actuator (see previous paragraph)
- Extract the obturator, unscrewing the locking nut (F)
- Replace the obturator, screw on the locking nut (F) and then fit the actuator
- Insert the fixing clip, respecting the correct direction
- Reconnect the connector.

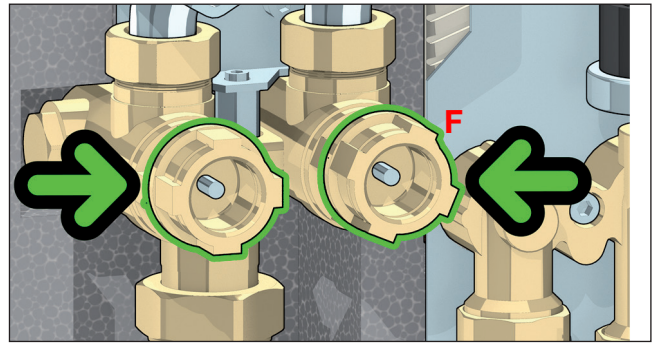

Replacing the DHW priority flow meter

- Disconnect the flow meter cable acting on the connector
- Extract the flow sensor (G)
- Position the new sensor
- Reconnect the connector respecting the only possible way it can be inserted.

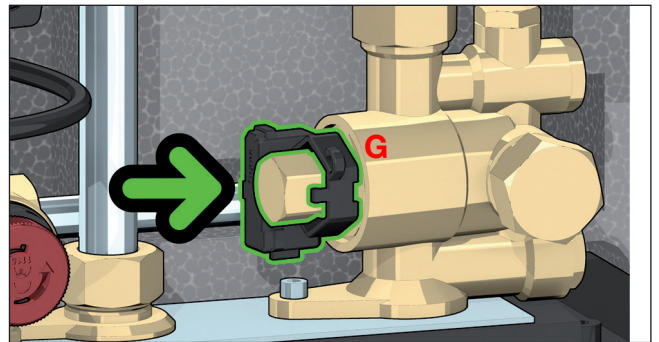

Replacing or cleaning the DHW priority flow meter turbine

- Extract the flow sensor
- Unscrew and remove the cartridge (H)
- Remove any impurities or change the cartridge if necessary
- Screw the cartridge back in
- Reposition the flow sensor

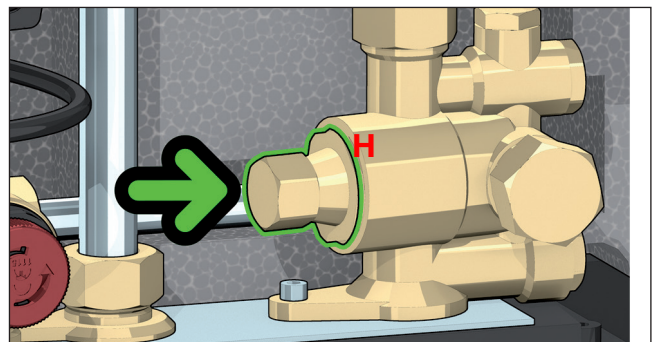











When carrying out maintenance on the electrical part, follow the indications on page 19 for the connections.

After concluding maintenance, proceed with the filling and checking operations described in the chapter "commissioning" (page 9) and fit the cover.

If you require any information regarding spare parts, please contact Caleffi spa.

Troubleshooting

FAULT DESCRIPTION	ALERTS	POSSIBLE CAUSE OF FAULT	OPERATIONS TO BE PERFORMED
Domestic hot water is not heated	blinking  icon	primary circuit shut-off valves closed	open the valves
		modulating valve actuator disconnected from valve body	reconnect actuator
		modulating valve actuator faulty	call qualified personnel to have it replaced
		DHW temperature probe cable inverted with heating probe	restore correct connection
		presence of air in the system	vent the system
		electronic regulator not working	call qualified personnel to have it replaced
		valve obturator blocked in closed position	call qualified personnel to have it replaced
		centralised system not working/cold	contact person in charge of system
	error code 6 active	DHW temperature probe disconnected	reconnect probe
		DHW temperature probe faulty	call qualified personnel to have it replaced
	error code 80 active	incorrect wiring/no credit	check electrical connections/top up credit
	fixed  icon	DHW priority flow meter disconnected	reconnect flow meter
		DHW priority flow meter faulty	call qualified personnel to have it replaced
	icon  absent	DHW production not enabled	enable DHW production by means of HIU interface
display is off	electric supply cut off	restore HIU electric supply	
	protection fuse burnt out	call qualified personnel to have it replaced	
The water is hot but does not reach the desired temperature	blinking  icon	domestic water cycle temperature set point too low	increase set point
		primary return temperature limitation intervention	change the return temperature set point/ disable the function
		primary circuit strainer of the HIU clogged	call qualified personnel to have it serviced
		exchanger partly clogged	call qualified personnel to have it serviced
		modulating valve actuator faulty	call qualified personnel to have it replaced
		DHW temperature probe cable inverted with heating probe	restore correct connection
		excessive demand for DHW	decrease demand
		electronic controller not working	call qualified personnel to have it replaced
		centralised system temperature insufficient	contact person in charge of system
		primary circuit flow rate insufficient	contact person in charge of system
		primary flow rate limit too low	contact person in charge of system
Hot water temperature is too high	blinking  icon	domestic water cycle temperature set point too high	decrease set point
		DHW temperature probe cable inverted with heating probe	restore correct connection
		modulating valve actuator faulty	call qualified personnel to have it replaced
		valve obturator blocked in intermediate or open position	call qualified personnel to have it replaced
		electronic regulator not working	call qualified personnel to have it replaced
		primary circuit excessive flow rate due to DPCV valve malfunction	call qualified personnel to have it replaced
		Antilegionella cycle in progress	contact person in charge of system
Hot water flow rate is insufficient	blinking  icon	HIU strainer clogged	call qualified personnel to have it serviced
		possible domestic water system shut-off valves partially closed	open the valves
		insufficient pressure in centralised domestic water circuit	call qualified personnel to have it serviced
Hot water flow rate is zero	-	possible domestic water system shut-off valves closed	open the valves
		no cold water in centralised domestic circuit	call qualified personnel to have it serviced
		HIU strainer completely clogged	call qualified personnel to have it serviced
		exchanger completely blocked	call qualified personnel to have it serviced

FAULT DESCRIPTION	ALERTS	POSSIBLE CAUSE OF FAULT	OPERATIONS TO BE PERFORMED
The room does not reach the desired temperature	blinking  icon	heating cycle temperature set point too low	increase set point
		chrono-thermostat temperature setting incorrect	check programming of chrono-thermostat
		HIU strainer clogged	call qualified personnel to have it serviced
		primary return temperature limitation intervention (the following icon appears )	change the return temperature set point/ disable the function
		primary flow rate in heating mode set at an excessively low limit	change heating valve opening limit
		heating valve actuator faulty	call qualified personnel to have it replaced
		heating valve obturator blocked	call qualified personnel to have it replaced
		modulating valve actuator connector disconnected	reconnect actuator connector
		DHW temperature probe cable inverted with heating probe	restore correct connection
		presence of air in the system	vent the system
		pump not working	call qualified personnel to have it replaced
		pump cable not connected	restore connection
		possible system shut-off valves/terminals closed	open the valves
		centralised system temperature insufficient	contact person in charge of system
		electronic regulator not working	call qualified personnel to have it replaced
		primary circuit flow rate insufficient	contact person in charge of system
		centralised system not working	contact person in charge of system
		thermostat function enabled on the remote user interface when it should be disabled	contact person in charge of system
	fixed  icon	chrono-thermostat time setting incorrect	check programming of chrono-thermostat
		chrono-thermostat not working	check chrono-thermostat
		thermostat function disabled on the remote user interface	contact person in charge of system
	display is off	Electric supply cut off	restore HIU electric supply
		Protection fuse burnt out	call qualified personnel to have it replaced
	icon  absent	Heating not enabled (summer mode)	enable heating by means of heat interface unit
	error code 4 active	heating circuit pressure too low	restore system pressure
	error code 5 active	heating temperature probe faulty	call qualified personnel to have it replaced
	error code 15 active	compensation temperature probe faulty	call qualified personnel to have it replaced
	error code 38 active	external temperature probe faulty/not connected	call qualified personnel to have it replaced
error code 69 active	safety thermostat cut-out	press the reset button/call qualified personnel to have it serviced	
error code 80 active	no credit	top-up prepaid system	

	Checks to be performed	
1	Is the heat interface unit properly secured to the wall?	
2	Has the system flushing been carried out?	
3	Check strainers and clean them if necessary	
4	Is the heat meter (if present) connected?	
5	Is the heat meter (if present) connected to the building datalogger (if required)?	
6	Is the DCW line fitted with a pressure reducing valve?	
7	Is the system protected by water hammer arresters?	
8	Are the shut-off valves open?	
9	Has the visual inspection of the hydraulic sealing efficiency produced positive results?	
10	Has the system (primary) been filled and vented?	
11	Has the system (secondary) been vented and filled to a pressure of between 1,2 and 2 bar?	
12	Has the visual inspection of the HIU internal electrical connections given a positive result and are the connections compliant with specifications and made in accordance with best practices?	
13	Is the heat interface unit connected to the 230 V ~ (AC) electric supply? Is the remote user interface connected?	
14	Have the optional connections (external sensor, prepayment, auxilliary microswitch, Modbus, if required) been carried out?	
15	Has the remote user interface been configured for installation on board (thermostat function disabled) / inside the apartment (with thermostat function enabled)?	
16	Have the heating, DHW and comfort functions (if required) been activated?	
17	Have the heating and DHW set points been configured correctly?	
18	Have the optional functions (return temperature limitation, return/weather compensation, anti-legionella, primary flow rate limitation) been enabled (if required) and configured?	
19	Have the external room thermostats (if required) been connected?	
20	No error code on heat interface unit remote user interface?	
21	Is the primary circuit at working temperature?	
22	Check that heating starts (blinking icon) by simulating a heating request	
23	Check that the pump functions correctly when the thermostat is activated (check that the secondary flow pipes heat up)	
24	Simulate minimal DHW tapping (approx 3 l/min) and check that "DHW" LED lights and that water is supplied at the required temperature	
25	Simulate abundant DHW tapping and check, by means of the installed heat meter, that the primary circuit flow rate is sufficiently high	

